

Sensor Description

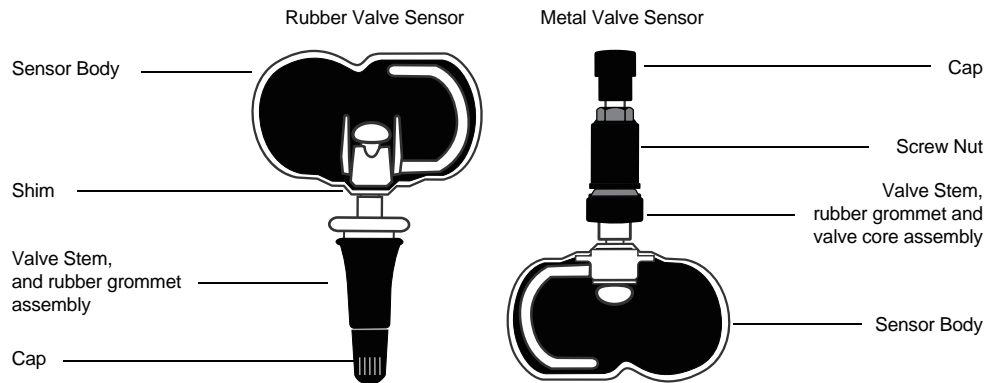

Please read this quick start guide carefully before installing the sensor. For safety reasons, we recommend that only trained technicians perform maintenance and repair work in accordance with the guidance of the car manufacturer. The valves are safety-related components and are only used for professional installation. Incorrectly installed TPMS valves and sensors may malfunction. Foxwell does not assume any liability in case of faulty or incorrect installation of the product.



Technical Data

| | |
|--------------------------------|-------------------|
| Operating Frequency | 315 MHz / 433 MHz |
| Pressure Monitoring Range | 0 to 800 kPa |
| Battery Life | 4-6 year |
| Vehicle Coverage | >96% |
| Test Accuracy | ± 5 kPa |
| Weight of Sensor without Valve | 12 g |

Sensor Installation

Foxwell T10 sensor are shipped blank and must be programmed with Foxwell TPMS tool, which is recommended to be performed prior to installation.

1. Deflating the tire

Remove the valve cover and valve core to deflate the tire.

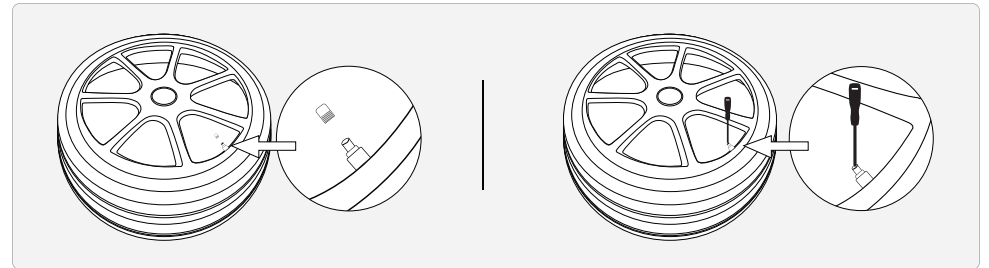

2. Dismantling the sensor

Place the tire in the tire machine with the TPMS sensor located 180° away from the bead breaker tool arm. Break the tire bead and remove the tire from the tire machine. Then use a suitable tool to dismantle the TPMS sensor. (Note* in some cases the tire may have to be removed entirely from the wheel)



Caution

Do not directly break the tire bead in the region of the TPMS sensor as it is easily damaged. If the TPMS sensor is a rubber valve snap-in type, please use the tire valve stem puller tool to remove.

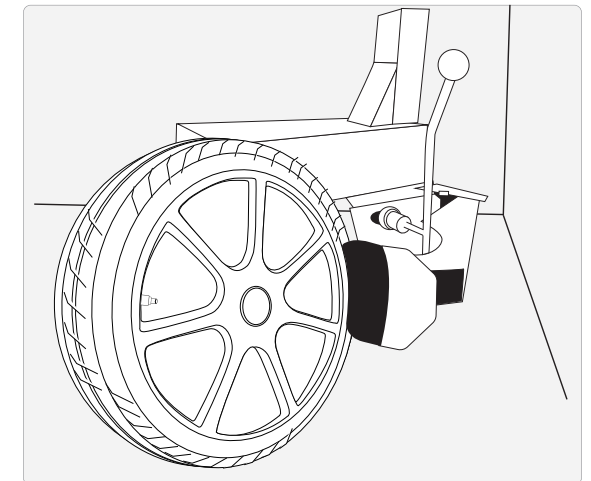

3. Installing sensor

⚠ Caution

When the tire is repaired or disassembled, or if the sensor is disassembled or replaced, the rubber grommet, grommet, screw nut and valve core must be replaced with Foxwell original parts to ensure proper connection. If the sensor is damaged externally, it must be replaced.

Metal Valve Stem Sensor Installation

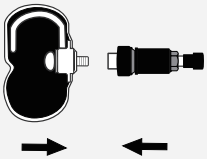

(1) Connect the sensor body and the valve stem.
(Screw on the back screw but do not tighten it for adjusting the angle.)

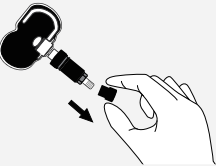

(2) Remove the cap, screw nut, and grommet from the stem one by one.

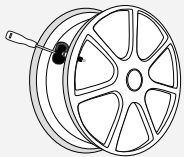

(3) Install the valve stem on the valve hole of the rim and adjust the angel between sensor body and the valve stem to fit hub. Then tighten the back screw.

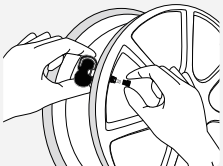

(4) Install the grommet, screw nut and cap on the stem.

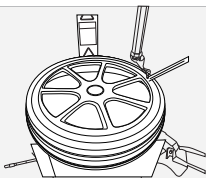

(5) Use the tire valve stem puller to pull the sensor to the proper position.

Rubber Valve Stem Sensor Installation

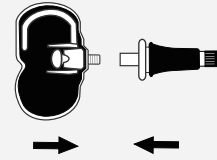

(1) Connect the sensor body and the valve stem.
(Screw on the back screw but do not tighten it for adjusting the angle.)

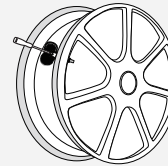

(2) Install the valve stem on the valve hole of the rim and adjust the angel between sensor body and the valve stem to fit hub. Then tighten the back screw.

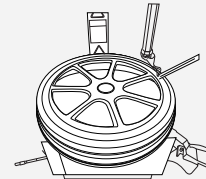

(3) Use the tire valve stem puller to pull the sensor to the proper position.

4. Inflating the tire

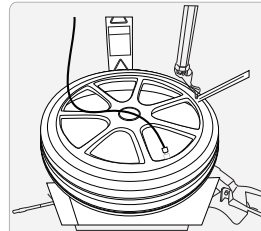

Dismantle the valve core with valve core removal tool. Then inflate the tire to the nominal value according to the tire data plate the vehicle. Install the valve core and screw the valve cap.

Contact Us

For service and support, please contact us.

- 🌐 WebSite: www.foxwelltech.us
- ✉ E-mail: support@foxwelltech.com
- ☎ Service Number: +86 - 755 - 26697229
- 📠 Fax: +86 - 755 - 26897226

